

AMMBT4403-HF (PNP)

RoHS Device
Halogen Free

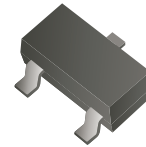

Features

- Epoxy meets UL-94 V-0 flammability rating.
- Moisture sensitivity Level 1.
- High conductance.
- AEC-Q101 Qualified.

Mechanical data

- Case: SOT-23, molded plastic.
- Terminals: Tin plated leads, solderable per J-STD-002 and JESD22-B102.

Circuit Diagram

1. Base
2. Emitter
3. Collector

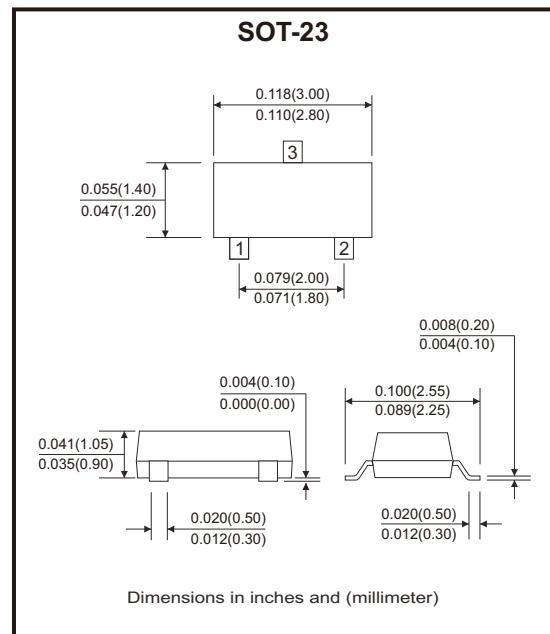
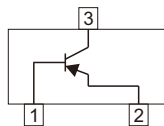

Maximum Ratings (at Ta=25°C unless otherwise noted)

Parameter	Symbol	Value	Unit
Collector-base voltage	V_{CBO}	-40	V
Collector-emitter voltage	V_{CEO}	-40	V
Emitter-base voltage	V_{EBO}	-5	V
Collector current-continuous	I_C	-600	mA
Total device dissipation	P_D	300	mW
Thermal resistance junction to ambient	$R_{\theta JA}$	417	K/W
Junction temperature range	T_J	-55 to +150	°C
Storage temperature range	T_{STG}	-55 to +150	°C

Electrical Characteristics (at Ta=25°C unless otherwise noted)

Parameter	Conditions	Symbol	Min	Max	Unit
Collector-emitter breakdown voltage	$I_C = -1\text{mA}$, $I_B = 0$	$V_{(BR)CEO}$	-40		V
Collector-base breakdown voltage	$I_C = -100\mu\text{A}$, $I_E = 0$	$V_{(BR)CBO}$	-40		V
Emitter-base breakdown voltage	$I_E = -100\mu\text{A}$, $I_C = 0$	$V_{(BR)EBO}$	-5		V
Collector cut-off current	$V_{CE} = -35\text{V}$, $I_B = 0$	I_{CBO}		-100	nA
Base cut-off current	$V_{CE} = -35\text{V}$, $I_E = 0$	I_{CEO}		-100	nA
Collector cut-off current	$V_{CE} = -4\text{V}$, $I_C = 0$	I_{EBO}		-100	nA
DC current gain	$V_{CE} = -2\text{V}$, $I_C = -150\text{mA}$	h_{FE}	100	300	
Collector-emitter saturation voltage	$I_C = -150\text{mA}$, $I_B = -15\text{mA}$	$V_{CE(sat)}$		-0.4	V
	$I_C = -500\text{mA}$, $I_B = -50\text{mA}$			-0.75	
Base-emitter saturation voltage	$I_C = -150\text{mA}$, $I_B = -15\text{mA}$	$V_{BE(sat)}$		-0.95	V
	$I_C = -500\text{mA}$, $I_B = -50\text{mA}$			-1.3	
Transition frequency	$V_{CE} = -10\text{V}$, $I_C = -20\text{mA}$, $f = 100\text{MHz}$	f_T	200		MHz
Delay time	$V_{CC} = -3\text{V}$, $V_{EB} = -2\text{V}$, $I_C = -150\text{mA}$, $I_{B1} = -15\text{mA}$	t_d		15	ns
Rise time		t_r		20	
Storage time	$V_{CC} = -3\text{V}$, $I_C = -150\text{mA}$, $I_{B1} = I_{B2} = -15\text{mA}$	t_s		225	ns
Fall time		t_f		30	

Rating and Characteristic Curves (AMMBT4403-HF)

Fig.1 - Static Characteristic

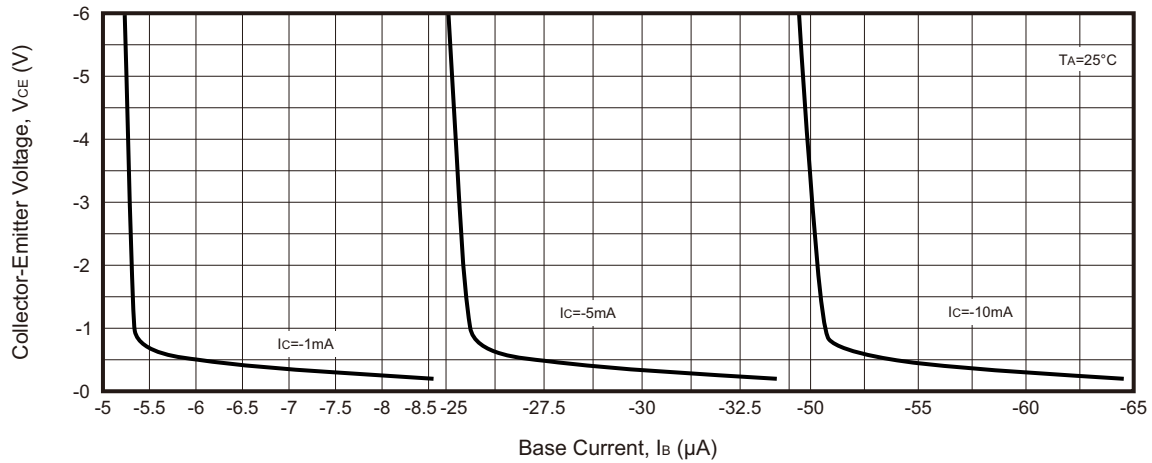

Fig.2 - $h_{FE} - I_C$

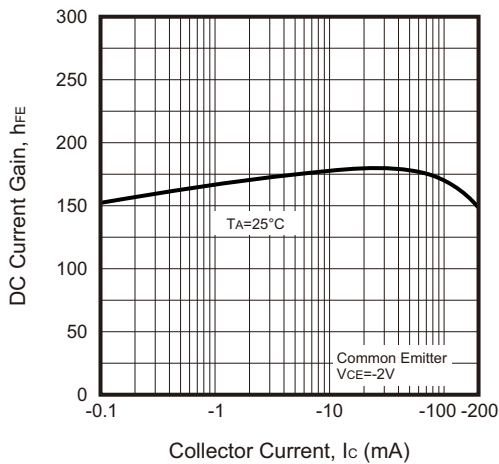

Fig.3 - $V_{CEsat} - I_C$

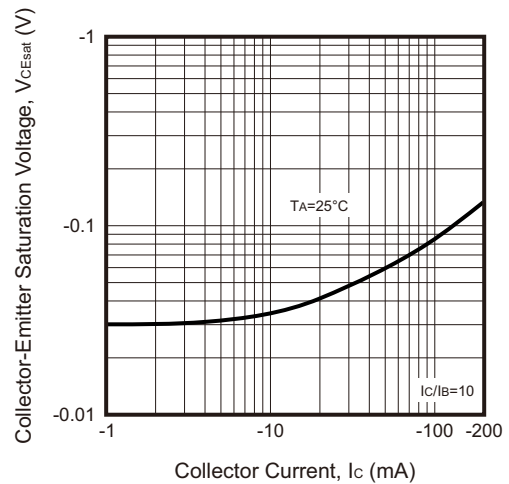
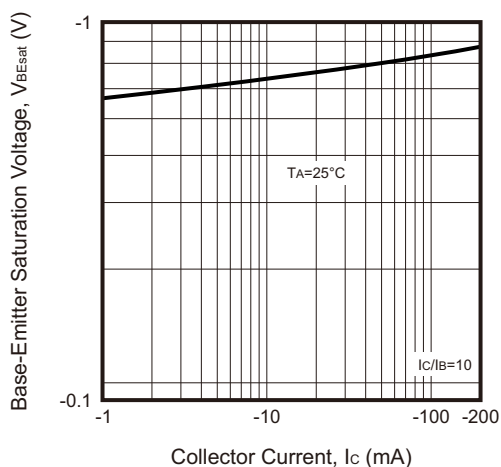

Fig.4 - $V_{BEsat} - I_C$



Company reserves the right to improve product design, functions and reliability without notice.

REV:A

Reel Taping Specification

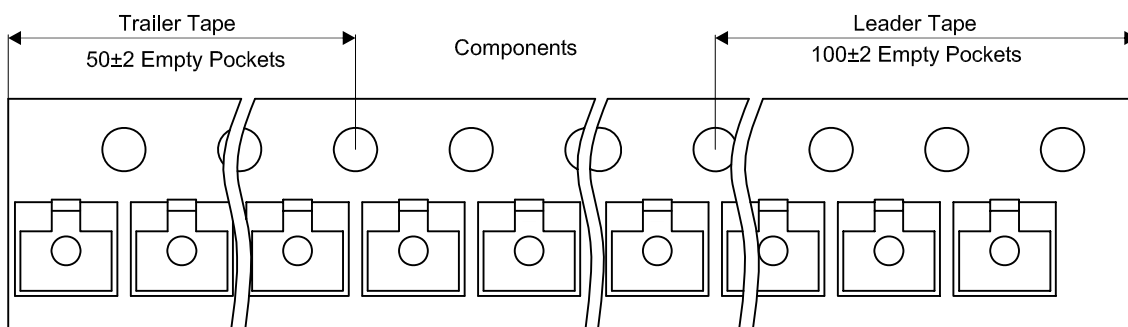
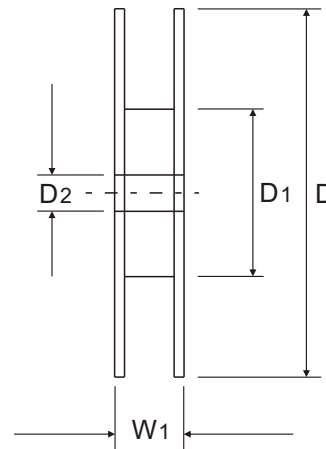
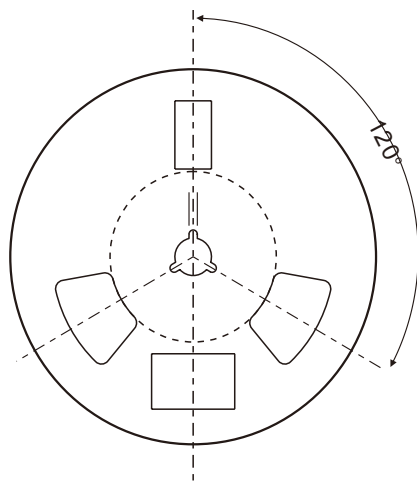
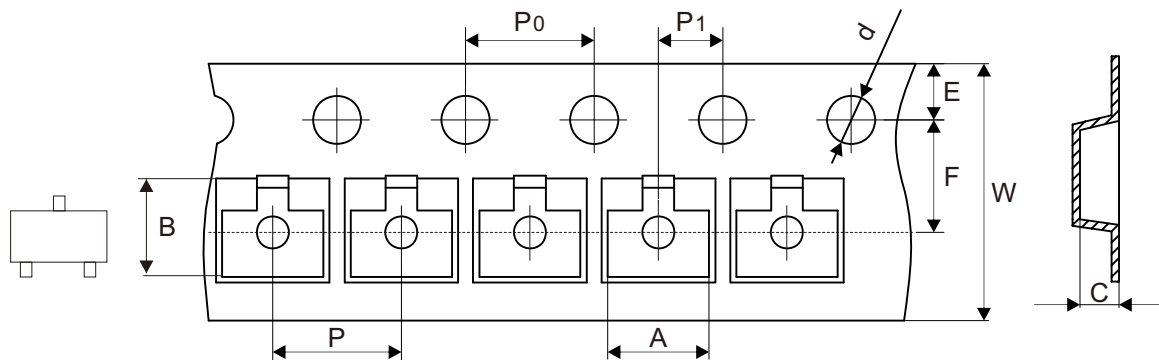

SOT-23	SYMBOL	A	B	C	d	D	D1	D2
	(mm)	3.15 ± 0.10	2.77 ± 0.10	1.22 ± 0.10	1.50 + 0.10 - 0.00	178.00 ± 1.00	54.60 ± 1.00	13.30 ± 1.00
	(inch)	0.124 ± 0.004	0.109 ± 0.004	0.048 ± 0.004	0.059 + 0.004 - 0.000	7.008 ± 0.039	2.150 ± 0.039	0.524 ± 0.039

SOT-23	SYMBOL	E	F	P	P0	P1	W	W1
	(mm)	1.75 ± 0.10	3.50 ± 0.05	4.00 ± 0.10	4.00 ± 0.10	2.00 ± 0.05	8.00 + 0.30 - 0.10	11.10 ± 0.20
	(inch)	0.069 ± 0.004	0.138 ± 0.002	0.157 ± 0.004	0.157 ± 0.004	0.079 ± 0.002	0.315 + 0.012 - 0.004	0.437 ± 0.008

Company reserves the right to improve product design, functions and reliability without notice.

REV:A

Marking Code

Part Number	Marking Code
AMMBT4403-HF	2T.

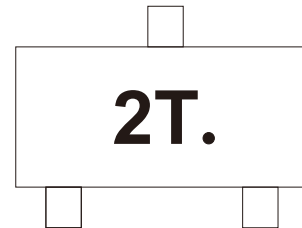

Suggested P.C.B. PAD Layout

SIZE	SOT-23	
	(mm)	(inch)
A	0.90	0.035
B	0.80	0.031
C	0.95	0.037
D	2.00	0.079
E	2.90	0.114

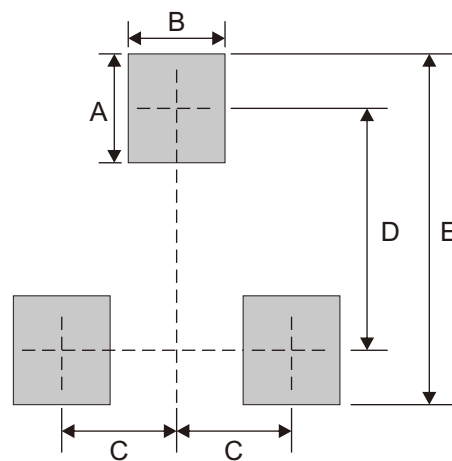

Note: 1. The pad layout is for reference purposes only.

Standard Packaging

Case Type	REEL PACK	
	REEL (pcs)	Reel Size (inch)
SOT-23	3,000	7